



REED SWITCH DEVELOPMENTS CORP.

2524 Norwood Court
Racine, WI 53403
Ph: (262)883-9060

sales@reedswitchdevelopments.com

SPECIFICATION SHEET

Part Number:

4004

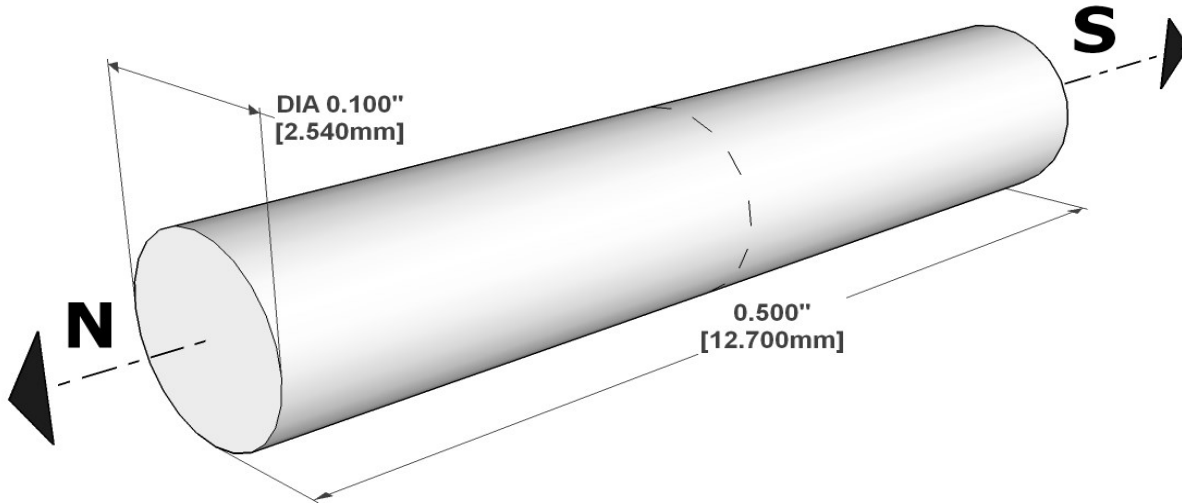

	Specifications	Description	UM
Physical/Magnetic	Material	Alnico	
	Grade	A5	
	Shape	Cylindrical/Rod	
	Diameter	0.10/2.54	Inches/mm
	Thickness	0.50/12.70	Inches/mm
	Magnetic Orientation	Axially Magnetized	
	Plating	None	
	Max Operating Temperature	975/525	°F/°C
	Curie Temperature	1580/860	°F/°C
	Pull-In Force	Standard Relative to Material/Grade/Mass	
	BR max	12800	Gauss
	BH max	5.5	MGOe
	Coercive Force Hc	640	Oe
	Intrinsic Coercive Force Hci	640	Oe

Assembly Certifications

RoHS	Y
Conflict Free Material	Y
Country of Origin	China

For More Information Visit:

www.reedswitchdevelopments.com

Or Call Us At:

[262-883-9060](tel:262-883-9060)

IT SHALL BE THE RESPONSIBILITY OF THE BUYER TO ENSURE THAT THE GOODS ARE SUFFICIENT AND SUITABLE FOR THE PURPOSE OR PURPOSES INTENDED (WHETHER BY THE BUYER OR BY ANY THIRD PARTY) AND THAT THEIR CAPACITY AND PERFORMANCE IS NOT ADVERSELY AFFECTED BY ANY ITEMS USED IN THEIR INSTALLATION (WHERE RELEVANT) AND/OR IN CONNECTION WITH THEM.