



**REED SWITCH DEVELOPMENTS CORP.**

2524 Norwood Court

Racine, WI 53403

Ph: (262)883-9060

[sales@reedswitchdevelopments.com](mailto:sales@reedswitchdevelopments.com)

**SPECIFICATION SHEET**

**2602-1901-100**

Alternate Part Number:  
**AM2602-1901-10-01**

Active / Equivalent Part Numbers:

2602-1901-100 - Magnetic Reed Sensor Only

AM2602-1901-10-01 - Magnetic Reed Sensor Only

Sensor (Reed) - Specifications		1901	
Physical	Configuration	SPDT	
	Form	C	
	Contact Position	OFFSET	
	Glass L	14.00	mm
	Glass D	2.30	mm
	Total L*	55.00	mm
	Wire D	0.53	mm
	Gap Location	OFFSET	
	Mount Spec*	THRU	
	Contact Material	RHODIUM	
	Max Vibration Resistance	20	G
	Max Shock Resistance (11ms)	50	G
	Lead Tensile Strength	N/A	KG
	Operating	Pull in (+/- 2AT)*	15-20
Drop out*		5	AT
Operate Time		2.0	ms
Bounce Time		0.60	ms
Release Time		0.50	ms
Resonant Frequency		N/A	Hz
Max Operating Frequency		250	Hz
Operating Temperature Range		-40 - 105	°C
Storage Temperature		N/A	°C
Electrical		DC Contact Rating	20
	AC Contact Rating	20	VA
	DC Switching Voltage	150	VDC
	AC Switching Voltage	150	VAC
	DC Switching Current	1.00	A
	AC Switching Current	1.00	A
	DC Max Carry Current	2.00	A
	AC Max Carry Current	2.00	A
	Min Breakdown Voltage	200	VDC
	Max Initial Contact Resistance	150	mOhm
	Typical Initial Contact Resistance	N/A	mOhm
	Max Contact Capacitance	0.80	pF
	Min Insulation Resistance	10 <sup>9</sup>	Ohm

\* Pre-processed, bare reed element

**2602-1901-100  
Magnetic Reed Sensor**

DIA 0.313" [7.950mm]  
5/16-24 THREAD

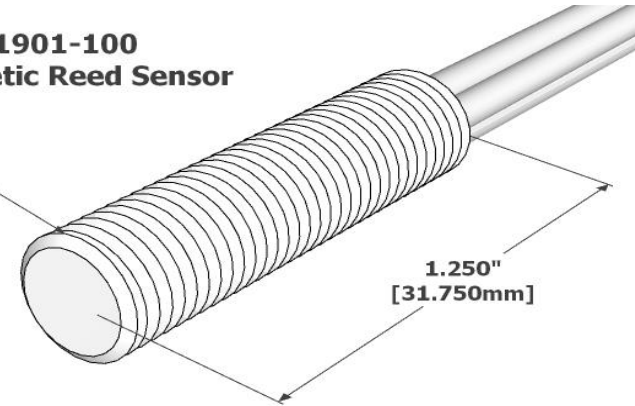

All measurements are in Inches [millimeters]

For More Information Visit:

[www.reedswitchdevelopments.com](http://www.reedswitchdevelopments.com)

Or Call Us At:

262-883-9060

**Sensor - Wire/Cable Characteristics (cont.)**

Type	Wire
Conductor Count	3
Length	6.0"/152.4mm
Colors	RED, BLK, WHT
Insulation Material	PVC
Gauge	24 AWG
Stranded Copper	7 STR-TC
Maximum Temp	105°C

**Housing Characteristics 2602**

Cylindrical Threaded (5/16-24)	
Length / Thickness	1.125"/28.58mm
Diameter	0.313"/7.95mm
Material	Stainless Steel

**Conductor Configuration**

Common - WHITE
Normally Open (NO) - RED
Normally Closed (NC) - BLACK

**Standard Sensor/Actuator - Min. Actuation Distance**

2602-4002-000	0.31"/7.9mm
---------------	-------------

**Assembly Certifications**

UL Recognized (File #: E102207)	Y
RoHS / Reach Compliant	Y
Conflict Free Material	Y

REV DATE: 10/06/2021

DISCLAIMER NOTICE: INFORMATION FURNISHED IS PROPRIETARY, AND IS BELIEVED TO BE ACCURATE AND RELIABLE, AND IS SUBJECT TO CHANGE WITHOUT NOTICE. IT SHALL BE THE RESPONSIBILITY OF THE BUYER TO ENSURE THAT THE GOODS ARE SUFFICIENT AND SUITABLE FOR THE PURPOSE OR PURPOSES INTENDED (WHETHER BY THE BUYER OR BY ANY THIRD PARTY) AND THAT THEIR CAPACITY AND PERFORMANCE IS NOT ADVERSELY AFFECTED BY ANY ITEMS USED IN THEIR INSTALLATION (WHERE RELEVANT) AND/OR IN CONNECTION WITH THEM.

**WBE Certified - State of Wisconsin - MFR CAGE CODE: 32604**

[www.reedswitchdevelopments.com](http://www.reedswitchdevelopments.com)